

ARKAT ALÜMİNYUM

ENERJİNİZİ TAŞIYORUZ

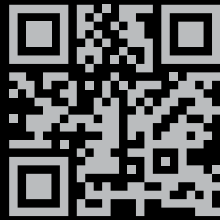

www.arkataluminyum.com

Aşık Sistemleri

ARKAT SERİ

ARKAT ALÜMİNYUM

6 cm Aşık Profili
1796
1063 gr/m

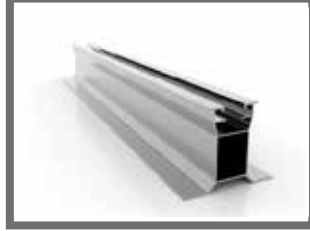
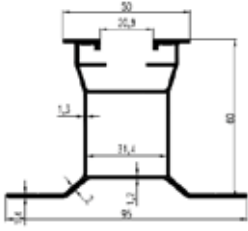

8 cm Aşık Profili
1818
1215 gr/m

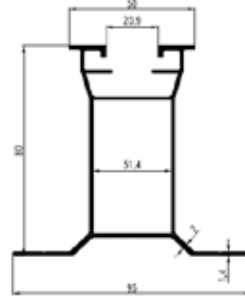

10 cm Aşık Profili
1795
1446 gr/m

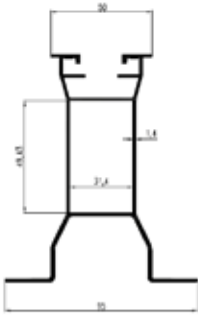

Alüminyum Özel Somun

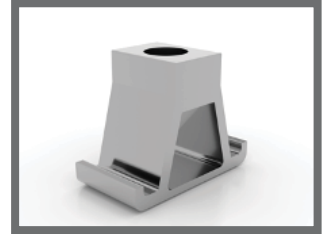
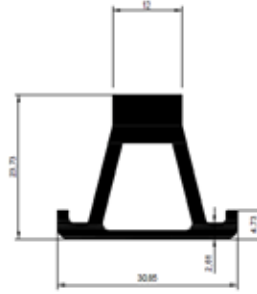

Kulaklı 5,5 cm Aşık
1788
998 gr/m

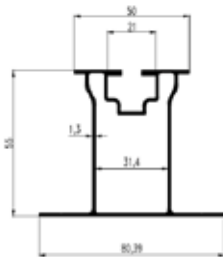

Kulaksız
1787
944 gr/m



5 cm Kulaksız Aşık Profili
50-3
737 gr/m

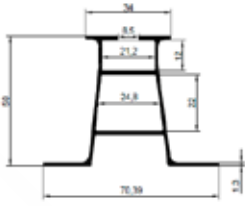

5 cm Kulaklı
Aşık Profili
50-4
789 gr/m

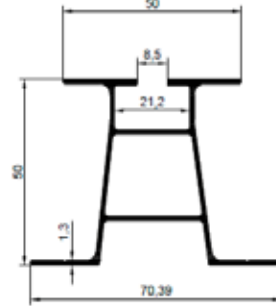

6 cm Aşık Profili
60-2
862 gr/m

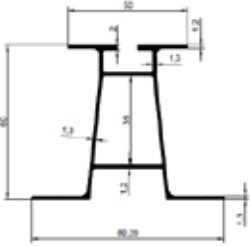

8 cm Aşık Profili
80-1
997 gr/m

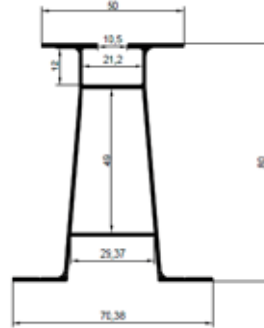

10 cm Aşık Profili
100-1
1143 gr/m

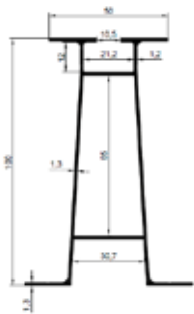

Dikdörtgen Somun
Mx8



Aşık Sistemleri

BRAKET SİSTEM

Aşık Profili
1820
999 gr/m

L BRAKET

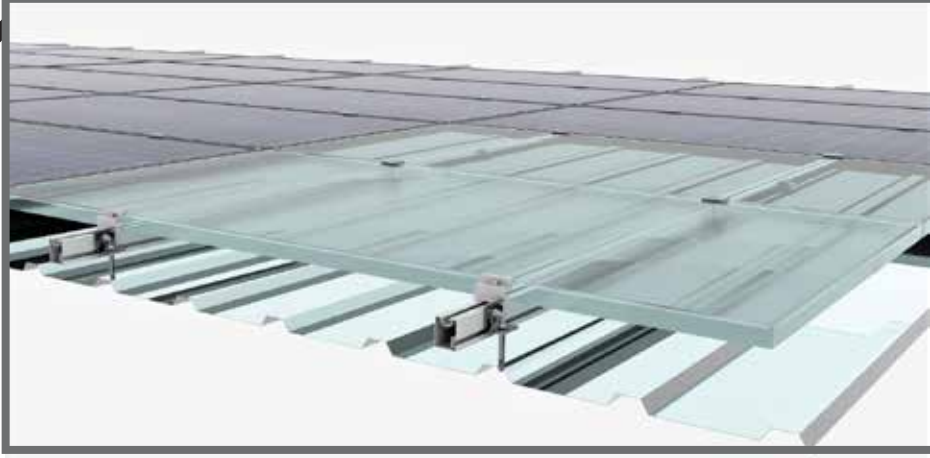
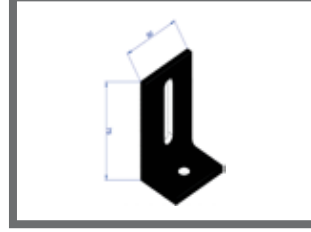
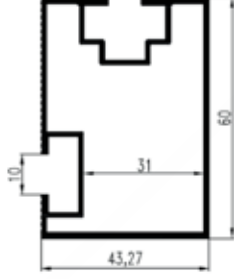

Aşık Profili
820-M02
776 gr/m

Kutu Braket

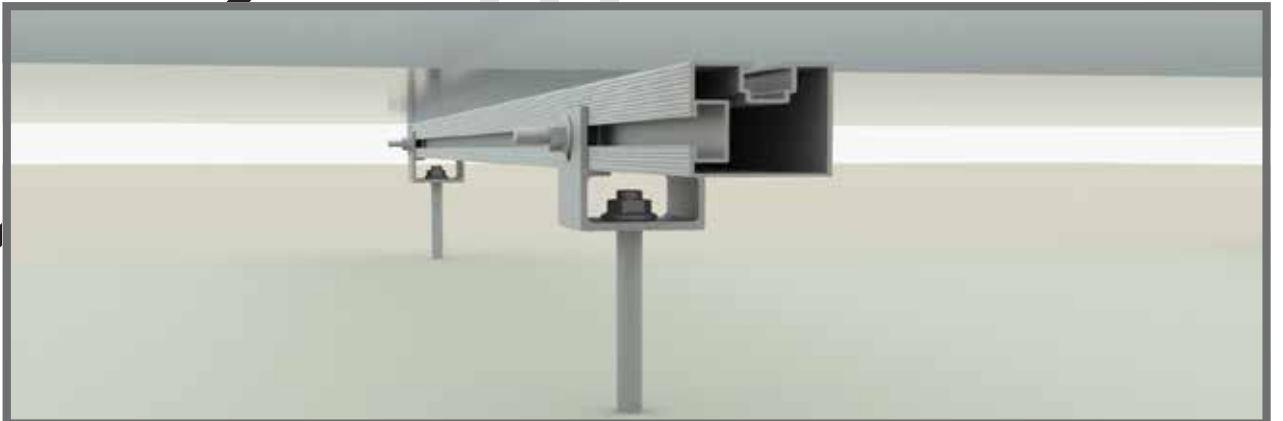
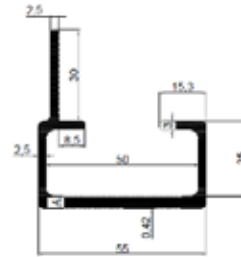

Aşık Profili
1804
1014 gr/m

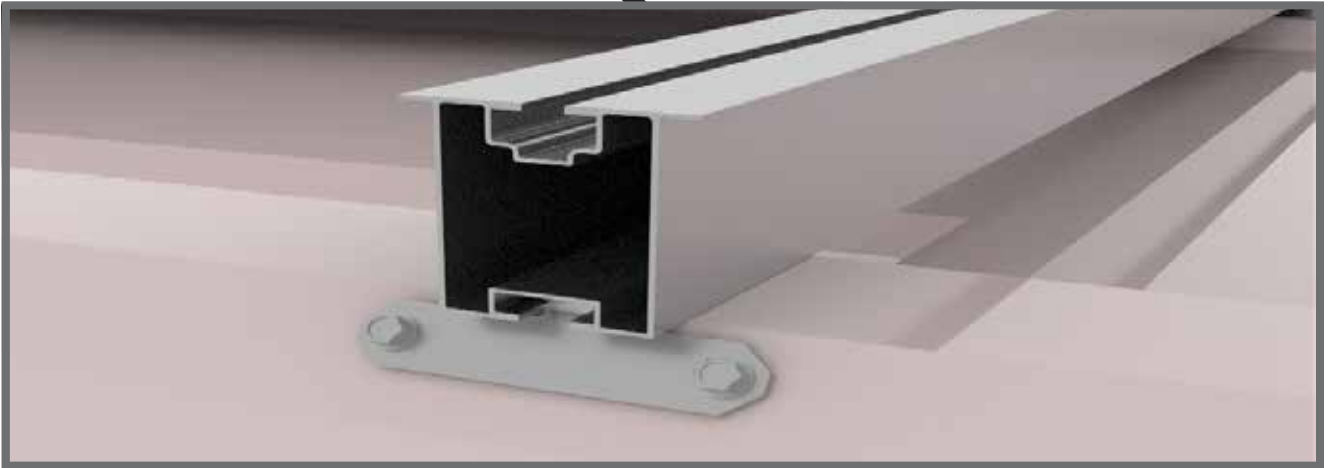
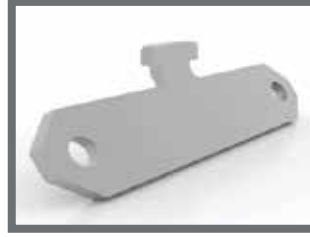
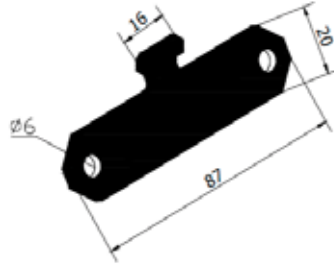

Aşık Sistemleri

KREMİT ÇATI SİSTEMLERİ
ÇATI KANCA SİSTEM

ARKAT ALÜMİNYUM

1951
6087gr/m

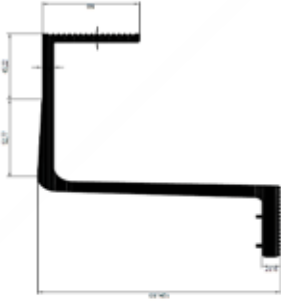

1952
2411 gr/m

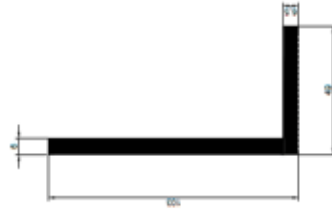

1950
5432 gr/m

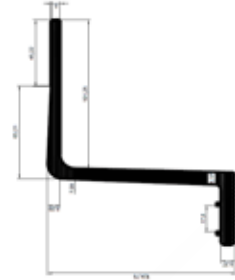

ALTAN BAĞLAMA

Aşık Profili
1137-R
805 gr/m

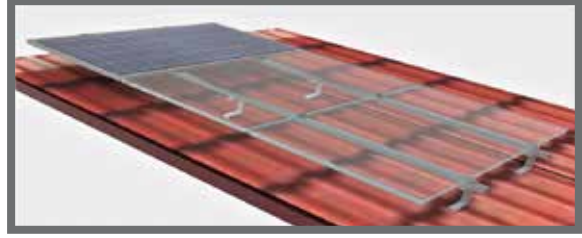
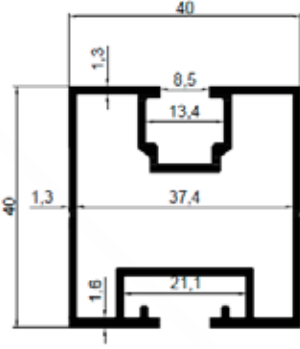

YANDAN BAĞLAMA

Aşık Profili
820-M02
776 gr/m



KİREMİT SIKIŞTIRMA

Aşık Profili
820-M3
747 gr/m

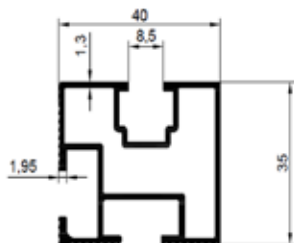

Aşık Sistemleri

ARAZİ SİSTEM

ARKAT ALÜMİNYUM

1629
1450 gr/m

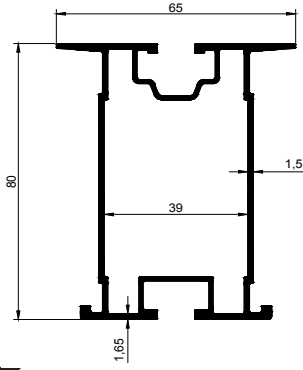

1642
1165 gr/m

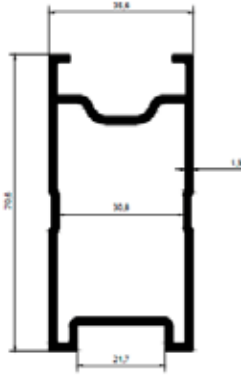

Üst Ray
YB-M02
872 gr/m

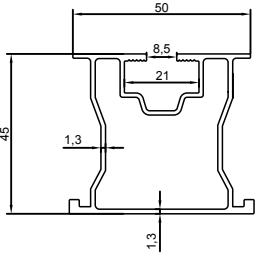

Alt Ray
1809
714 gr/m

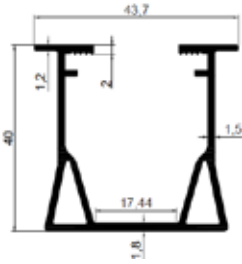

Yan Bağlantı Profili 34mm
1782
378 gr/m

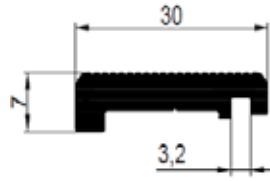

Alüminyum Çektirme Somunu
1839
615 gr/m

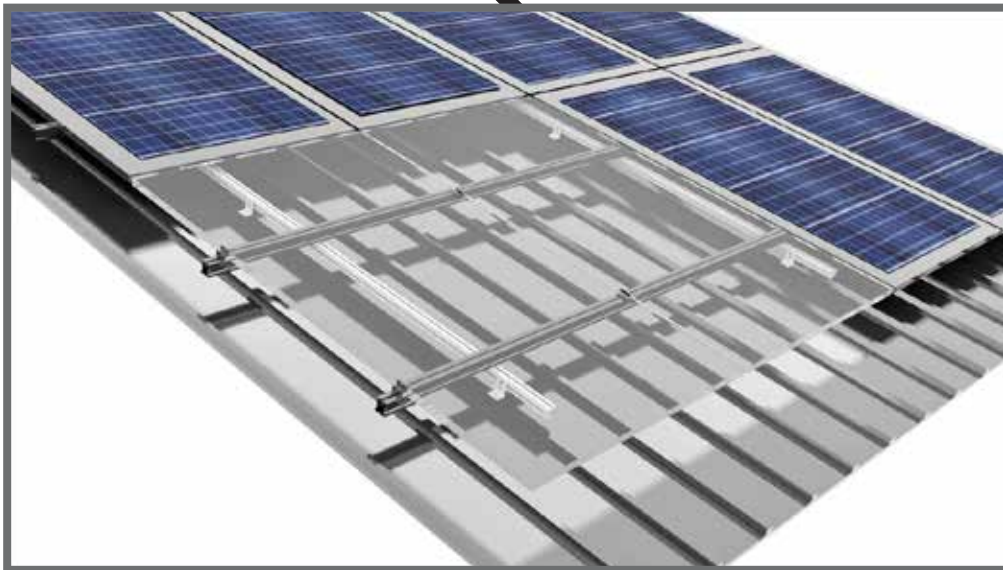
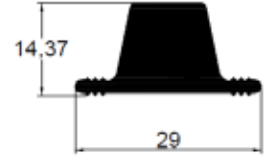

Üçgen Sistemleri

13 DERECELİK 29 CM
ÜÇGEN SİSTEM

ARKAT ALÜMİNYUM

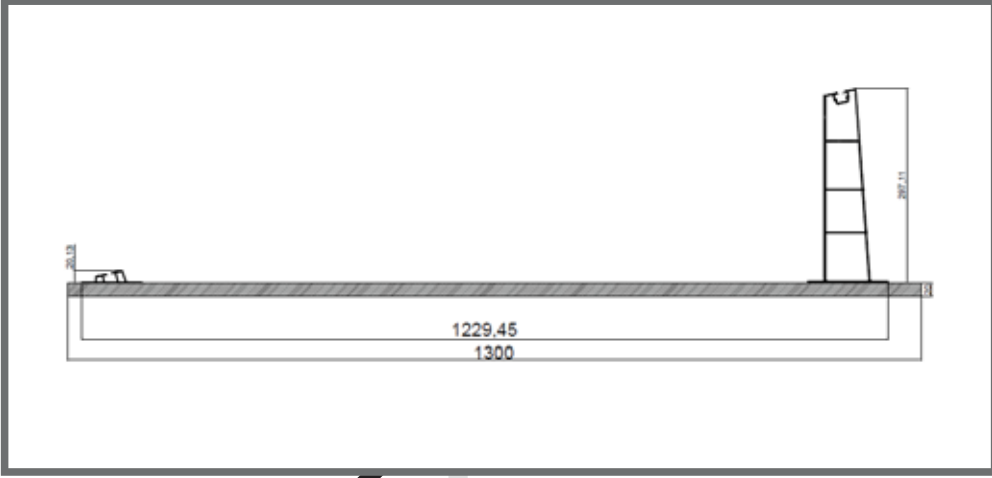

Üçgen Sistemleri

YENİ NESİL 13 DERECELİK
ÜÇGEN SİSTEMİ

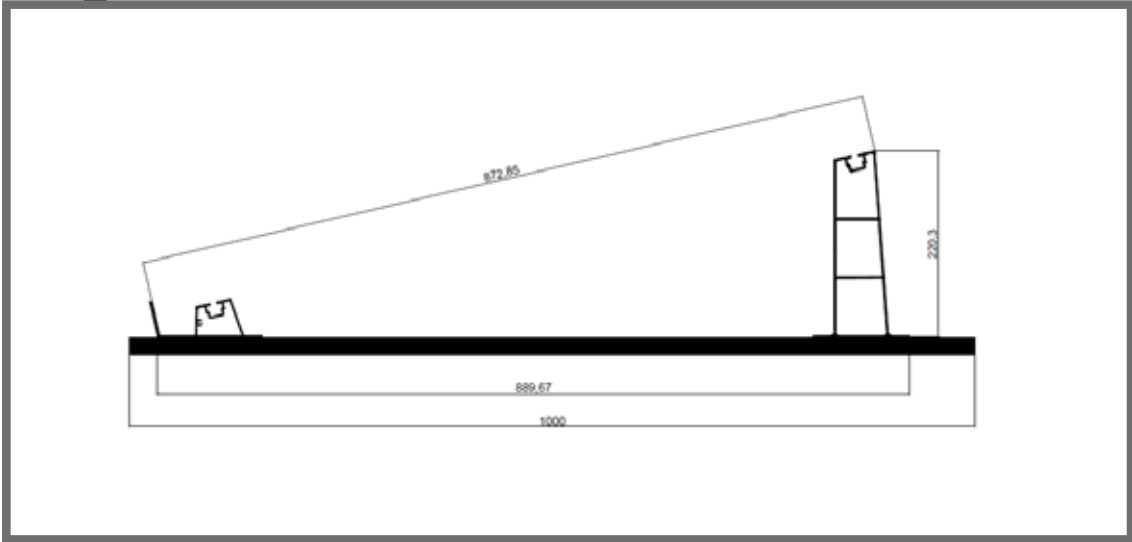

Üçgen Sistemleri

13 DERECELİK PARÇALI
ÜÇGEN SİSTEM

ARKAT ALÜMİNYUM

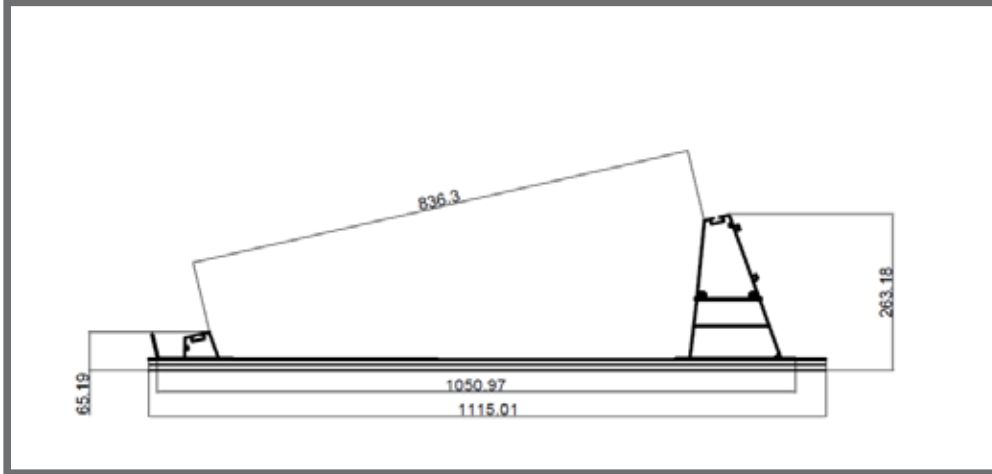
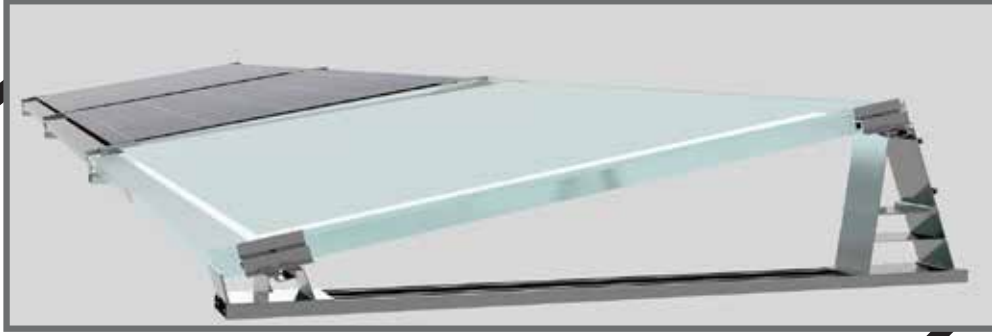

Üçgen Sistemleri

15 DERECELİK ÜÇGEN SİSTEMİ

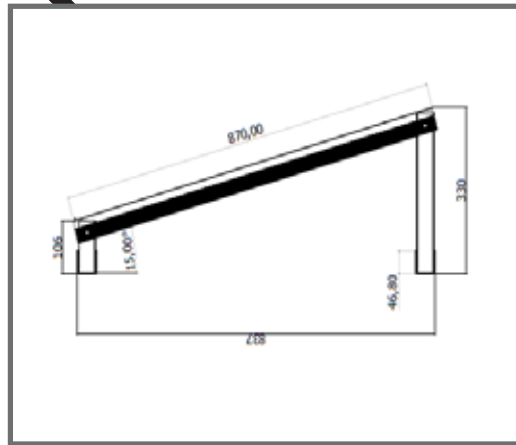
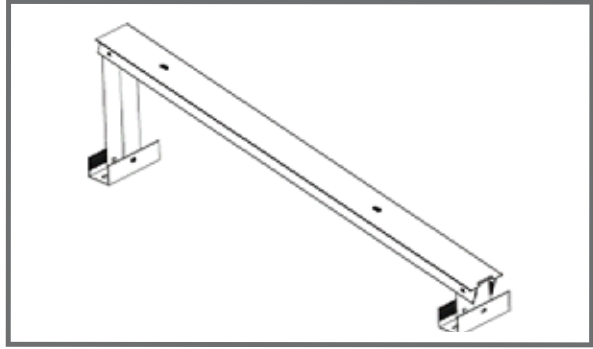

Klemp Sistemleri

ARK SERİSİ 60 mm



35'lik End Klemp
693
791 gr/m

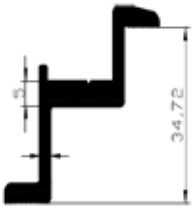

40'lik End Klemp
705
832 gr/m

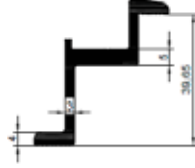

Mid Klemp
694
731 gr/m

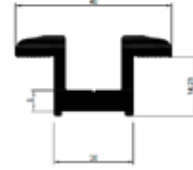

YENİ NESİL SERİ 50 mm

35'lik End Klemp
1134
461 gr/m

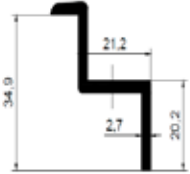

40'lik End Klemp
1621
661 gr/m



Mid Klemp
1136
456 gr/m

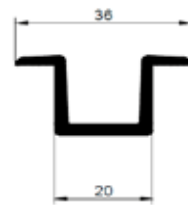

H-SERİSİ 80 mm

35'lik H-End
1624
634 gr/m



40'lik H-End
1750
675 gr/m



H-Mid
1623
772 gr/m



Kelepçe Sistemleri

1837 1838
1127 gr/m 2008 gr/m

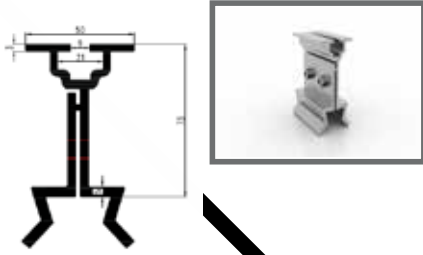

1851 1852
1325 gr/m 2246 gr/m

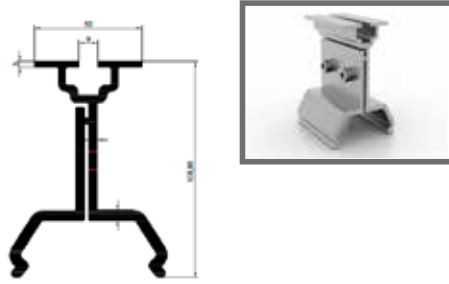

1873 1872
1227 gr/m 2108 gr/m

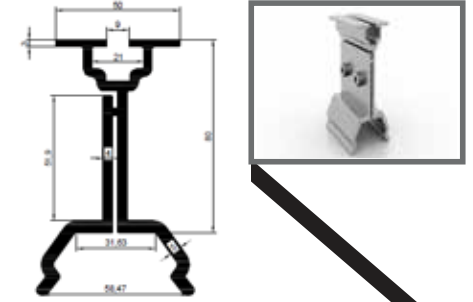

1928 1927
1028 gr/m 1907 gr/m

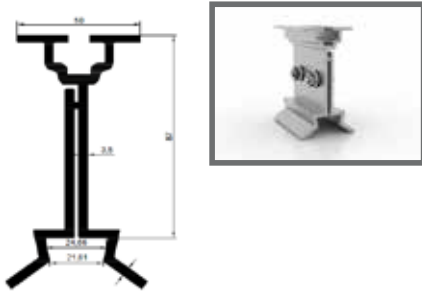

1747 1748
1382 gr/m 829 gr/m

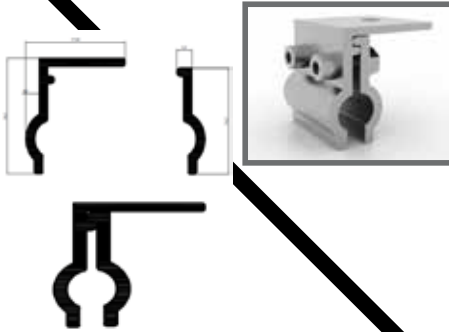

1794
3140 gr/m



130-131

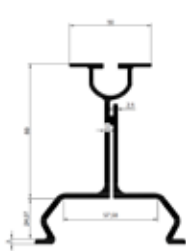

Assan Panel

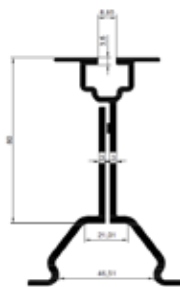

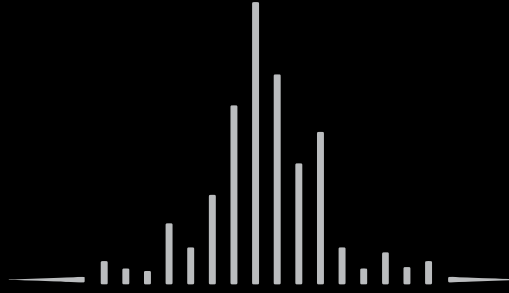

ARKAT ALÜMİNYUM

Nilüfer Organize Sanayi Bölgesi Minareliçavuş OSB 120. Sk. No: 5 Nilüfer / BURSA
Tel: +90 224 411 06 20 - Fax: +90 224 411 06 21 - Gsm: +90 539 589 27 88
finans@arkataluminyum.com